

TENSILON®

Universal Material Testing Machine
RTF Series

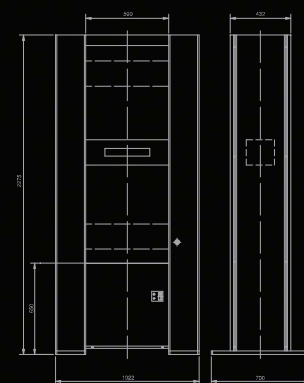

RTF-2410

RTF

- A&D's world-class Class 0.5 testing machine
- Machine design and structure precisely calculated to provide superior stiffness
- Highly accurate measurement control technology enabling sensor and machine connection



...Clearly a Better Value

A&D Company, Limited
<http://www.aandd.jp>

A&D's Universal Material Testing Machine TENSILON, which was developed using our superior knowledge of force sensor and measurement control technology, enables connection between sensors and machines. Our strength in this field is well-known and A&D has gained worldwide recognition from a range of businesses and laboratories.

We are very proud of our sensors, which are built to industry standard specifications. They are used not only for electronic balances, plant equipment and engine testing systems but also for use in national standard instruments.

Our measurement control system at the core of our testing machines offer the highest accuracy and most rapid calculation in the world. Its operation is even more advanced when teamed with MATLAB/Simulink and GUI configuration tool VirtualConsole software.

The TENSILON RTF is our newest universal testing machine offering innovative measuring possibilities, based on A&D's newly-developed and extensive technological knowledge. The RTF series is the world's best Class 0.5 testing machine. Having improved the overall design and structure of the machine, we achieved a very strong load frame stiffness enabling super-high accuracy in measurement. We also took the informed opinions of machine operators into consideration in order to improve the performance and functions of our model.

The TENSILON RTF Series heralds the beginning of a new era in measurement.

TENSILON

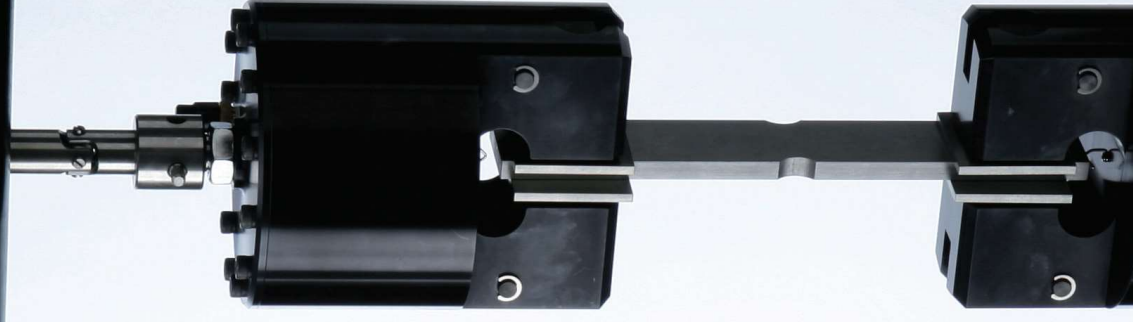

High performance

A&D's advanced universal testing machine, the TENSILON RTF series, offers superior high performance

Load measurement accuracy

Class 0.5

A&D's world-class Class 0.5 testing machine

The TENSILON RTF series is fully compliant with ISO/IEC 7025, as well as all measurement law requirements. The force sensor load cell developed for the TENSILON models has a built-in calibration circuit and a rating capacity function for easy calibration.

30% Improvement

Load frame stiffness has been greatly improved by 30% (Compared with our RTC series)

Load range

Rated output accuracy of up to 1/500 is guaranteed (Load range can be automatically set)

1 msec

High-speed sampling 1 msec

13 channels Max

A maximum of 13 input signal channels
Load/displacement data can be saved in a USB memory. High-speed sampling of input signals (including load/displacement) of up to 13 channels.

COLOR

Color touch panel (option)

Visibility and operation are substantially improved with color display of operation status and data.

12 types

Various operational environments

To fulfill diverse user needs, the color touch panel, MSAT, commander and display can be combined to create a flexible operational environment.

The TENSILON RTF series - an advanced universal testing machine
Strong New Product Lineup



Highest level of measurement and control

RTF-2430, RTF-2425
RTF-2410, RTF-2350, RTF-2325

Floor models / Maximum capacity of 300kN to 25kN
Maximum effective stroke of 500mm

Balance excellence

RTF-1350
RTF-1325

Table / Maximum capacity of 50kN to 25kN
Maximum effective stroke of 500mm

Compact

RTF-1310, RTF-1250
RTF-1225, RTF-1210

Table / Maximum capacity of 10kN to 5kN
Maximum effective stroke of 420mm

Color touch panel

The color touch panel offers superb visibility and easier operation

Either the color touch panel (OP-01) or MSAT data processing software (on a PC) can be selected for user interface.

Color display(data): The touch panel displays digital values as well as stress and strain curves. (Operation buttons): These buttons are highlighted in color and with symbols for easy recognition and to prevent errors during operation. (Setting items): Input columns and verification of conditions are easily distinguishable with background colors to prevent errors during operation. (Option items): Pull-down menu options in the same format as Windows ().

Analog record: Usable with an XY analog recorder or the AR-6600 series analog recorder, for the RTF and RTG series.

Digital record: Load and displacement data can be digitally converted to be saved in a USB memory.

Measurement conditions memory: Up to 10 measurement conditions files can be saved in the memory. It is useful to register measurement conditions that are used frequently so that the operator can start a new measurement with ease.

Automatic back-up/start-up system for measurement conditions: The last measurement conditions just before the machine is turned off will be automatically saved. When the machine is turned on again, it will begin operating with these saved measurement conditions so the operator can easily begin a new measurement.

Test speed: Condition settings of constant crosshead speed (mm/min), constant load increase speed (N/min) and constant elongation speed (mm/min) come as standard [extensometer is optional].

Test mode: Standard test (tensile/compression/bending) mode, Peeling test mode, Cycle test mode, Creep test mode, etc.
Load calibration mode: A load calibration can be performed using A&D's load cell loop-type dynamometer, the AD-1661 (sold separately).
Displacement and load display resolution: Up to 1/1000.

Touch panel positioning:
 The sliding touch panel can be easily moved up or down. It can also be attached to either pole.



(Factory option: Please specify which pole you would prefer to have it attached to.)

RTF with touch panel	Required (OS)	MSAT	Optional	Display	Optional	Commander	Recorder	Optional
----------------------	---------------	------	----------	---------	----------	-----------	----------	----------

1 Test Screen

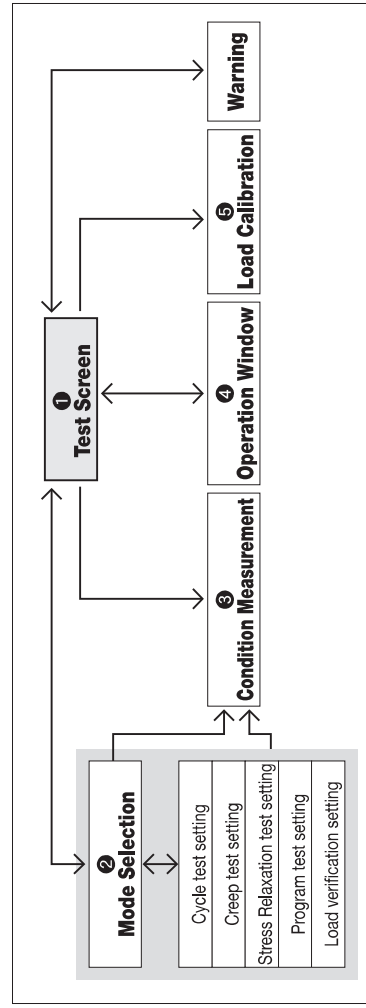
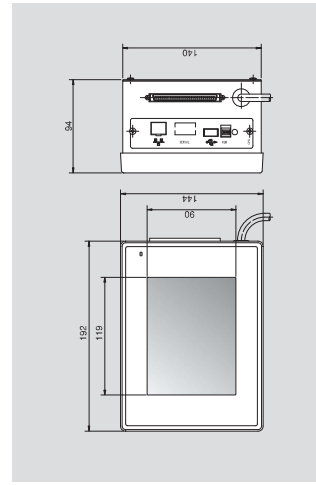

2 Mode Selection

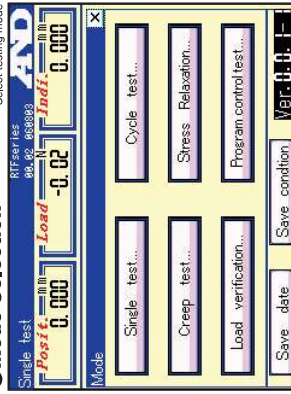

3 Condition Measurement

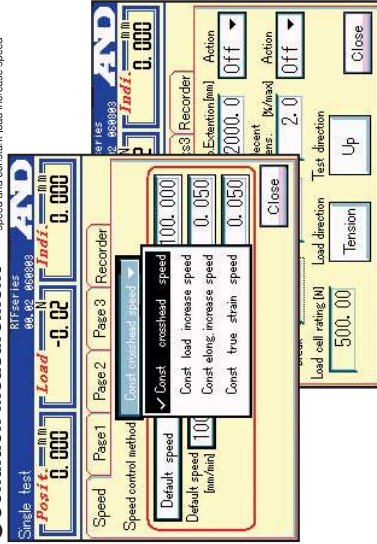

4 Operation Window

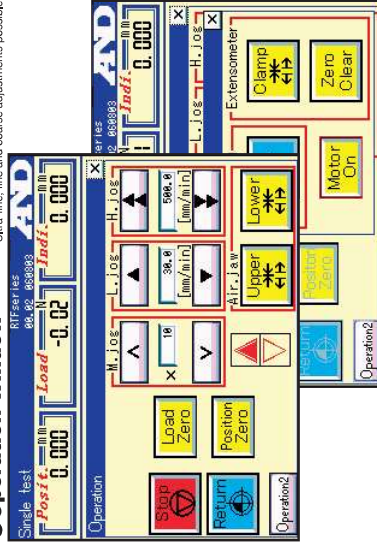

5 Load Calibration

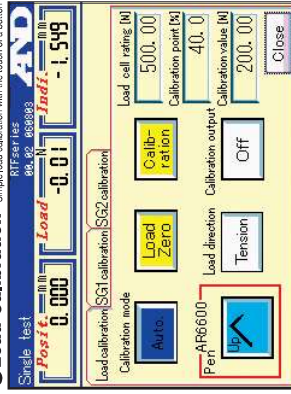

MSAT (Multi Signal Analysis Testing)

Data processing software for comprehensive control of a testing machine

The MSAT series is equipped with functions for not only testing machine operation but also data analysis, calculation and data storage for each testing mode. The operator can select Standard test (tensile, compression and bending) mode, Peeling test mode, Cycle test mode, Creep test mode, Stress relaxation test mode, etc., depending on the purpose of the test.

Measurement conditions file: Each measurement conditions file can be managed as an independent file using Windows Explorer.

Measurement conditions file configuration: Five basic windows detailing sample information, machine condition, analysis condition, graph display and table display with each window's functions categorized for easy operation.

Displaying and hiding settings: Measurement conditions settings file can be omitted from the screen. By hiding unwanted items from view, errors in setting will be eliminated leading to more efficient operation.

Restriction of settings input: Input of setting items can be restricted to avoid input errors.

Changing names: The name of each setting can be easily changed to suit the user.

Graph Window: An ongoing load and displacement graph can be displayed in real-time during the measurement. Different graph types such as single display, overlaying (comparison between current data and previous data) or inching are possible.



Arbitrary formula: Easy table calculation is possible by applying an arbitrary formula to data from sample dimensions and maximum point data obtained from load and displacement data.

Data browsing and processing: Previous data can be easily retrieved from the database structure employed for data storage. Easy data browsing and tabulation are also possible with Windows-based standard interface (Open Database Connectivity).

Data export: Measurement conditions, analysis values, and stress & strain (S-S) curves of measured data can be exported into a text file format or an Excel file format. With an Excel file format, tabulation and graphing are very simple and the copying and pasting of such graphs and tables is also possible.

Quick judgment: The upper and lower limits of the validity judgment of a result can be set in advance so that judgment can be made during measurement.

Reanalysis: Using the Reanalysis button, data can be reanalysed with the cursor on a load and elongation graph.

Recalculation: It is possible to recalculate a measurement result of previous data under altered analysis conditions.

Personal computer operation environment	OS: Windows XP Professional (English), CPU: Pentium (A) 1G H.z. or faster, Memory requirement: 512Mb or over, Authority requirement: Administrator authority, USB: One USB port, Display resolution: 1024x728 dots or higher color display.	MSAT	Touch panel	MSAT	Display	Commander/Recorder
		Optional	Optional	Required	Optional	Optional
		Optional	Optional	Optional	Optional	Optional

Standard layout setting during a measurement

Standard layout setting during a measurement

Graph Display Window

An ongoing load and displacement graph can be displayed in real time. Overwriting or inching are possible. The operator can easily make a comparison between current measurement data and previous measurement data with an inching graph. The elongation (S) can be plotted on the X-axis, Load force unit (N, etc.) or stress (stress unit MPa, etc.) can be plotted on the Y-axis.

Table Display Window

Load stress/displacement values at the maximum point, load stress/displacement values at the proof stress, load stress/displacement values at the 6 intermediate points, sample dimensions, etc. can be set and calculation results will be displayed immediately. A number of data, average/standard deviation, or standard deviation x 3, etc., can also be displayed.

Status Display Window

A test can be started or stopped on the screen, and fine or coarse adjustments of the machine can also be performed.

Operation Conditions Window

The crashrate speed (test speed setting) and automatic load cell rating recognition can be confirmed on the screen.

Sample Information Window

Sample information can be input on this screen. Up to 7 items in reference to the sample, test date, name of test operator, etc., can be entered and these items will be assigned for data designation.

Detailed Conditions Window

By clicking on the screen, settings for the recorder (if used), load/displacement limit values for the testing machine, machine, output limit operation, etc. can be input.

Dimension Table Window

Input in advance on the screen in order to perform the specified measurement and calculation and therefore reduce test operation.

Analysis Condition Window

This window is closely related to the table display. Setting of reference point of midpoint, designation of measurement range for elasticity degree, etc. can be input on the screen. After calculation, the calculation results table calculation can be performed using allowed settings by clicking on the recalculation button. To calculate elongation, the calculation function connecting looseness of a sample can be set.

Table Display Window

Load stress/displacement values at the maximum point, load stress/displacement values at the proof stress, load stress/displacement values at the 6 intermediate points, sample dimensions, etc. can be set and calculation results will be displayed immediately after the completed measurement. Statistical values such as maximum/minimum value, number of data, average/standard deviation, or standard deviation x 3, etc., can also be displayed.

Arbitrary Calculation Formula Window

This window is used to create a table calculation on the screen by applying a formula to the values of the table. For example, load value at maximum point is set in column A, sample width in column B, sample width in column C, and the calculation formula is "A/B*100" is entered in column D. The calculation results will be displayed on the table by clicking on the table.

Reanalysis Window

It is possible to recalculate data such as elastic modulus, maximum point, break point stress-strain curve (S-S curve). The validity judgment of a result is easily performed with a simultaneous display of both results produced before and after the reanalysis. It is also possible to obtain optimal analysis conditions from a graph and then setting such values on the reanalysis window enabling easy setting of test conditions.

Display & Commander

RTF series with user interface for advanced operation

Display

Detachable digital display for load and displacement indication. This display can be attached with magnets to any part of the machine and it does not obstruct the user when fixing a sample to the jig or testing a sample as its position can be freely adjusted.

Commander

Handy compact commander for testing machine control. This commander can be attached to the top, bottom, left or right of the testing machine digital display for load and displacement indication.

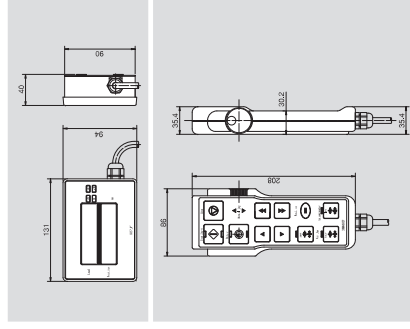

Display

Fixing method	Magnet attachment method
Display data	Load/displacement
Load	6-digit indication
Displacement	6-digit indication

Load

6-digit indication

The indication unit will be automatically selected from kN, N, mN or μ N.

Displacement

1/1000 display at minimum

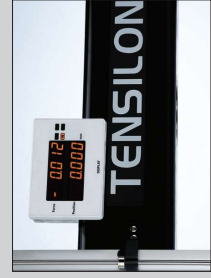

The detachable display offers a more organized and efficient workspace.



Commander

The commander's manual operation buttons are ergonomically designed with bright colors and varied sizes for superior ease-of-use. The jog dial on the right hand side of the commander offers extra flexible control and the operator can move the crosshead up and down by manually rotating this dial.

START

This button starts a test. The indicator lights up to show movement direction (up or down) of the crosshead.



RETURN

This button returns the crosshead to its original starting point. The movement slows down around this point to stabilize and provide an accurate return.



Up

This button controls minor upward adjustments of the moving crosshead.



Down

This button controls minor downward adjustments of the moving crosshead.



Air Jaw (Upper)

This button opens or closes the upper jaw when the air jaws are in use.



Air Jaw (Lower)

This button opens or closes the lower jaw when the air jaws are in use.



STOP

This button stops machine operation. When pressed, the touch panel and/or MSAT stop measuring data.



Manual Jog

The jog makes fine manual adjustments of the moving crosshead possible.



Up (fast)

This button controls major upward adjustments of the moving crosshead.



Down (fast)

This button controls major downward adjustments of the moving crosshead.



Position Zero

This button returns the crosshead to its original starting point.



Extensometer (Clamp)

This button opens or closes the contacts of the contact type extensometer between gauge marks (GL).

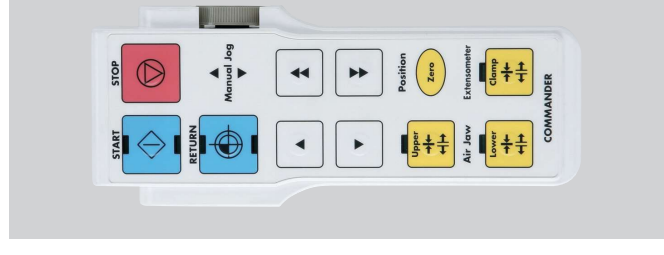

Application

A&D's wide range of applied products for even more advanced applications

Applied test jigs for strength measurement

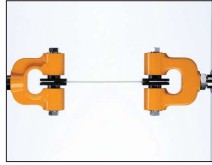

Screw action jaws
Applicable load: 1N (100gf) - 5kN (500kgf)
 These are screw action jaws, which are tightened by hand and suitable for use with low or mid-capacity tests. Various types of jaw faces are available depending on the size and shape of the test sample.

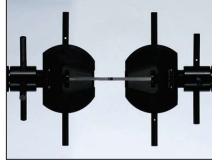

Wedge action jaws
Applicable load: 1kN (100kgf) - 300kN (30t)
 These are wedge action jaws suitable for use with low or mid-capacity tests. Various types of jaw faces are available depending on the size and shape of the test sample.

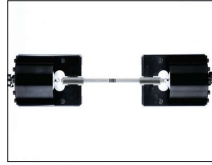

Air jaws
Applicable load: 50N (5kgf) - 10kN (1t)
 These are screw action jaws suitable for use with low or mid-capacity tests. Various types of jaw faces are available depending on the size and shape of the test sample.
The air vent air jaws specifically used for cords or threads are also available.

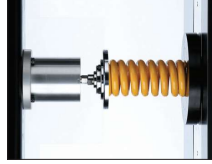

Compression test jig
Applicable load: 25N (2.5kgf) - 300kN (30t)
 This jig is composed of a compression anvil mounted on the base of a testing machine and a load cell sensitive plate mounted on a load cell, and is designed to correspond with testing machine and load cell capacities.

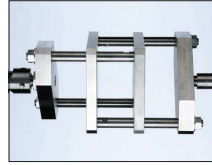

Compression cage
Applicable load: 50N (5kgf) - 300kN (30t)
 This jig is used to convert a tension force into a compression force.

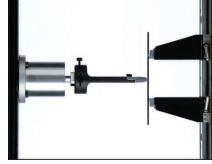

Compression type bending test jig
Applicable load: 1kN (100kgf) - 300kN (30t)
 This bending test jig meets various testing standards such as JIS, ISO and ASTM.



SG series strain gauge device for measuring distance between gauge marks
 This compact and lightweight strain gauge extensometer is attached to a test sample, which measures the elongation between gauge marks. Various types of SG are available depending on the distance between gauge marks or the volume of the extension.



Non-contact extensometer between gauge marks
U-4410
 This is an electronic optical / detecting system extensometer that makes high-precision measurement of the distance between gauge marks possible without any contact.

Applications

LOT SET Application

When used with the MSAT0002 / 0003 series, sample information will be automatically saved in a table format with the measurement result after each set of completed tests.

Table

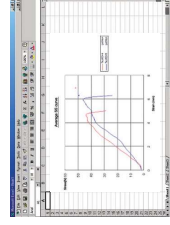

Excel PU

When Excel PU is used with the MSAT0002 / 0003 series, it is possible to overwrite the saved averaged S-S curves on an Excel graph to display a comprehensive outline of results.

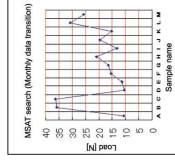

Quality control application

With the Microsoft Access report wizard, a graph detailing monthly or annual transitions can be displayed. This function is best suited for quality control.

Applied testing devices for temperature / environment test

Constant temperature / constant humidity testing devices • High temperature in vacuum testing devices • Ultra-low temperature testing devices • High temperature in gas atmosphere testing devices • Dipping testing devices

Model	Temperature range	Remarks
TKC	RT to +270°C	
TLF	-35°C to +270°C	Cooling using refrigerator
TCF	-60°C to +270°C	Cooling using liquid CO ₂
TCLF	-60°C to +270°C	Cooling using refrigerator and liquid CO ₂
TLLF ₂	-85°C to +250°C	Two-step refrigerator
TNF	-150°C to +250°C	Cooling Liquid N ₂
TLF • HS	-35°C to +270°C	Cooling using refrigerator with temperature adjustment



Constant temperature and constant humidity testing instruments

Data Recorder



Analog recorder (AR-6600-7)

This recorder is equipped with a control panel providing easy setup with one-touch zero-span adjustment and auto ranging.

Load frame & recorder table



Dimensions (mm)	Wing (sold separately)
For RTF-1350 and RTF-1325	420mm(W)x450mm(D)
For RTF-1310, RTF-1250, RTF-1225 and RTF-1210	660(W)x555(D)x630(H)

Can be mounted on either the right or left side.

Model	RTF-2430	RTF-2425	RTF-2410	RTF-2350	RTF-2325	RTF-1350	RTF-1325	RTF-1310	RTF-1250	RTF-1225	RTF-1210
Table / Floor model	Table model										
Loading system	Closed-loop microcomputer controlled digital servomechanism										
Maximum capacity	300 k N	250 k N	100 k N	50 k N	25 k N	50 k N	25 k N	10 k N	5 k N	2.5 k N	1 k N
Effective test width	590mm										
Crosshead stroke	1265mm	1160mm									
Effective stroke	640mm	620mm	748mm	718mm	548mm						
Crosshead speed	0.0005~500mm/min										
Crosshead speed accuracy	±0.1% during a steady operation in test speed range of 0.05 to 500mm/min.										
Crosshead random speed	0.0001mm/min step in crosshead speed range										
Crosshead speed and load capacity	Maximum load capacity in full speed range										
Crosshead return speed	500mm/min or 250mm/min										
Load measurement accuracy	±1% of reading (1/1 - 1/500 of load cell rating)										
Load range	Fully automatic range switching (up to 128 folds)										
Load calibration	One touch operation load calibration with the calibration circuit embedded in the load cell. Equipped with a load cell rating discrimination function										
Sampling speed	1msec										
Safety function for overload	Provided										
Stroke limiter	Upper/lower limit 2 points										
Dimensions (WxDxH)	1200×750×2470 (mm)										
Weight	1300kg										
Power supply	200V AC, 3φ, 50/60Hz, 3m cable without a plug										
Power consumption	6000VA										
Ambient temperature & humidity	Temperature: 5 to 40°C, Humidity: 20 to 80% RH										

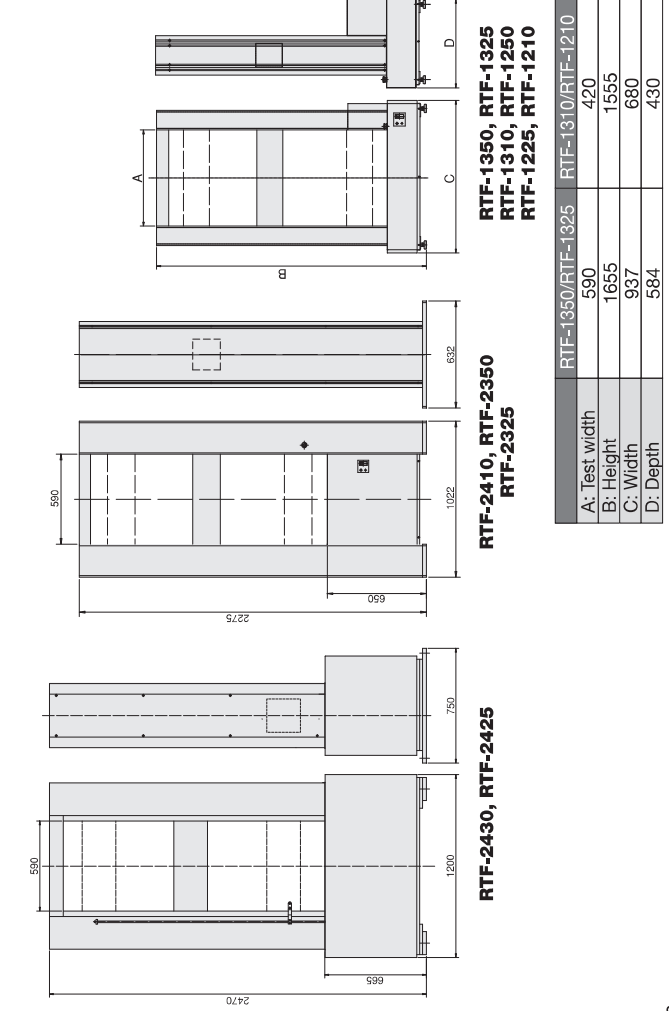

Operation unit	Touch panel	MSAT series
Method	Select from the touch panel or MSAT (installed in personal computer)	
Applicable model	All RTF series models	
Displacement display resolution	0.001mm	
Input channel	Maximum 13 channels (including load, crosshead movement and external displacement gauge)	Maximum 3 channels
Output channel	2 channels for analog data of load and elongation	Database file
Data storage method	CSV method (up to 12 input channels for digital data)	PC hard disc
Storage media	USB memory (at user's end)	Provided
Sample break detection function	Provided (slowing down the return speed around the origin to eliminate misalignment)	
Return function to the original point	Provided (Air jaws are required)	
Air (pneumatic) jaw open/close function		

A&D has received uniaxial testing machine calibration accreditation

A&D Company Limited has been accredited in the field of mass weighing Technology and Evaluation to meet the requirements of the measurement law, relevant regulations and JIS7025 (ISO/IEC17025 compliant) and received calibration accreditation with regard to uniaxial testing machines. This allows us to issue certificates of calibration with the JCSS accreditation. See the JCSS website for details. The JCSS accreditation which ensures conformity with the requirements of the measurement law, with regard to uniaxial testing machines. In order to ensure the reliability and safety of each product, the functions and performance of a material testing machine must be maintained and controlled at a high level. A&D will examine material testing machines and other technical services to our customers based on our advanced skills and extensive experience.

JCSS 0107

Calibration request

- At A&D, there are two types of calibration: JCSS accreditation and in-house calibration. JCSS calibration: A&D will issue a certificate with the JCSS accreditation symbol proving conformity with the requirements of national measurement standards. This certificate is suitable for the quality test of products for trade (a flat rate to be charged). In-house calibration: This calibration is performed according to our in-house calibration procedures to meet our customer's quality control requirements. We will issue a certificate and a traceability with regards to the standard devices used (a flat rate to be charged).
- Please submit your calibration request to your local sales representative.
- Calibration cost: Our quote will be based on the type of testing machine and the type of calibration, and will also include accommodation and transportation costs depending on the calibration location, etc. Please contact an A&D sales representative for further details.

AD-1661 series load cell loop type indicator for force calibration

Test and measurement

A&D's test, measurement and control equipment lineup

Judder testing machine

This machine is used to measure and evaluate friction characteristics such as temperature, frictional force, sliding velocity, etc. of steel plates, friction materials, ATF and additives of wet clutches.



[Specification] Max. pressure force: 5kN, Pressure setup: Arbitrary step, Sliding speed: 1-500R.P.M., Sliding speed setup: Arbitrary step, Friction force: 50N*mm, Temperature: 200°C, Heating system: Direct/indirect, Operation pattern: JASO M349 [Technical standard] JASO M349-01 Automatic transmission fluids-test method for anti-shudder performance

High-pressure environmental friction and wear tester

This testing machine is used to evaluate the frictional characteristics in a pressure container. It can evaluate the frictional characteristics of refrigerants, oil, friction materials, etc. for compressors and so on. There is a load cell inside the pressure container, which enables frictional-force measurement with high accuracy.



[Specification] Max. pressure force: 8kN, Sliding speed: 8000R.P.M., Friction force: 5N*mm, Pressure vessel: 5Mpa [Category of business] Compressor/Lubricating oil

Reciprocating friction and wear tester

This testing machine is used to evaluate surface conditions such as friction faces of materials by measuring the frictional force.



[Specifications] Pressure force: 100g - 5kg, Friction coefficient: 0.01 - 1, Friction faces moving distance: 10.0 - 30.0mm, Sliding speed: 6 - 600mm/min, [Category of business] Sliding matter/painted side/coating film

Bearing friction and wear tester

This testing machine evaluates the frictional characteristics of radial bearings. The circuit system adopted for the lubricant enables heating up to 80°C.



[Specification] Max. pressure force: 15kN, Sliding speed: 10000R.P.M., Safeguard: Printing prevention [Category of business] Bearing radial, Lubricant oil, Sliding material

Endurance testing machine for bed

This device is an endurance tester for ordinary home beds. It can also be used as a compression tester.



[Specification] Endurance test stroke: 0 - 150mm, Max. capacity: 1.5kN, Repetition speed: 160 time/min., Point of measurement: Programmable automatic operation measuring point compression, Testing speed: 1 - 500mm/min., Max. capacity: 2kN [Category of business] Bed, Mat and urethane

Large testing machine for timber

This device is used to conduct a three- / four-point bending test on wooden pillars. To facilitate the adjustment between the bearings, it is equipped with rails on the base as well as a trolley to transport the sample.



[Specification] Max. Capacity: 300kN, Distance between fulcrum (lower): 400 - 8100mm, Height to fulcrum: 400mm, Distance between fulcrum (upper): 200 - 2700mm [Category of business/technical standard] Column/square timber, JIS Z 2101 Test procedure for timber JAS

EFM-III

The measurement unit of A&D's conventional friction and wear tester has been adjusted to enable the measurement of friction characteristics with higher precision.



[Specification] Max. pressure force: 5kN, Pressure setup: Arbitrary step, Sliding speed range: 1 - 400mm/sec, Sliding speed setup: Arbitrary step, Friction force: 100/200N, Temperature: Max. 3ch (o.p.) [Category of business/technical standard] Hard/semi-hard fabrication resin, JIS K 7218 Testing Methods for Sliding Wear Resistance of Plastics

Automatic tensile testing machine

This device evaluates the tensile characteristics of plastics and plastic composite materials. The sample is automatically measured for its size and tested when set in the feed section. Very high-precision elasticity measurement is possible.



[Specification] Max. capacity: 10kN, Max. sample quantity: 100, Test sample storage: Palette or stockholder, Sample dimension point: Width, thickness and length [Technical standard] Hard/semi-hard plastic resin, JIS K 7161 Plastics - Determination of Tensile Properties, ISO 5271

Semi-automatic tensile testing machine

The controller of this testing machine automatically applies an appropriate load and puts the extensometer between the gauge lines, etc. after the sample is set. It provides measurement with high repeatability.



[Specification] Max. capacity: 10kN, Crosshead speed: 0.05 - 1000mm/min, [Category of business] At factory option, Rubber - Tensile properties, Plastics - Tensile properties, ISO 527/JIS K 7161

* Windows, Windows XP Professional, Microsoft Access and Microsoft Excel are registered trademarks of Microsoft Corporation.



For safety purposes!

● Read the relevant instruction manuals carefully before use.

A&D

A&D Company, Limited

...Clearly a Better Value

3-23-14 Higashi-Ikebukuro, Toshima-ku, Tokyo 170-0013 Japan
Telephone: [81] (3) 5391-6132 FAX: [81](3) 5391-6148
<http://www.aandd.jp>

● Appearance and/or specifications subject to change for improvement without notice.
● Contents of this catalog last updated March 2016.

RTF-ADCC-04-BD3-16402