

รวมสินค้าอุตสาหกรรมครบวงจร พร้อมราคาในเล่ม

บริษัท อีโตคินเทคโนโลยี จำกัด

CATALOG

WWW.ITOKIN2000.COM



ITOKIN
TECHNOLOGY



- 🔧 ครบวงจรสินค้าโรงงานอุตสาหกรรม
- 🔧 ราคาถูก...คุณภาพดีทนใจ
- 🔧 มีบริการพ่อน้ำ
- 🔧 บริการสอนเทียบเครื่องมือทุกประเภท
- 🔧 รับซ่อมเครื่องจักรทุกยี่ห้อพร้อมรับประกันงานซ่อม
- 🔧 ฟรี!! บริการจัดส่ง ติดตั้ง พร้อมเทรนนิ่ง



ช่องทางติดต่อเรา

โทร : 02-9744354-6

สายด่วน : 082-1288881, 081-7731860

Fax : 02-9744487

Email : salesitokin@gmail.com

COMPANY PROFILE

ITOKIN TECHNOLOGY

บริษัทไอทีคินเทคโนโลยีจำกัด
(สำนักงานใหญ่) ตั้งอยู่ซอยวิภาวดีรังสิต 33 แยก 1- 6
แขวงสนามบิน เขตดอนเมือง กรุงเทพฯ 10210
ได้ก่อตั้งบริษัทในปีพ.ศ. 2551 โดยเป็นผู้นำเข้ารายใหญ่
ด้านเครื่องมือวัด เครื่องมือทดสอบ และเครื่องจักรทาง
อุตสาหกรรมทุกประเภทรวมทั้งยังเป็นศูนย์บริการซ่อม
เครื่องมือวัด เครื่องมือทดสอบ และเครื่องจักรทุกชนิดทุก
ยี่ห้อทั้งเอเชีย ญี่ปุ่น และยุโรป

VISION การให้ความสำคัญของเรา

บริษัทของเราให้ความสำคัญกับคุณภาพของสินค้าการ
บริการที่รวดเร็วและบริการหลังการขายเพื่อให้ลูกค้าพึง
พอใจบริษัทมุ่งเน้นบุคลากรที่มีความเชี่ยวชาญพนักงาน
ของเราผ่านการอบรมด้านเครื่องมือวัด เครื่องมือทดสอบ
และเครื่องจักรจากต่างประเทศทั้งในด้านเทคนิคต่างๆ และ
การซ่อมและบำรุงรักษาถึงนี้ลูกค้าจะสามารถเชื่อมั่นได้ว่า
ราคาที่ได้รับอย่างเป็นธรรมแน่นอนพร้อมคุณภาพและ
บริการที่ดี

MISSION การบริการของเรา

- แนะนำ ให้คำปรึกษา ด้านเทคโนโลยีด้านเครื่องมือวัด เครื่อง
มือทดสอบ และเครื่องจักรสายการผลิต
- ผู้นำเข้าและจัดจำหน่าย เครื่องมือวัด
เครื่องมือทดสอบ และเครื่องจักรทุกประเภท
- ศูนย์บริการตรวจเช็ค รับซ่อม ติดตั้ง
เทรนนิ่งเครื่องมือวัด เครื่องมือทดสอบ และเครื่องจักร
- บริการสอบเทียบเครื่องมือวัด เครื่องมือทดสอบ

TARGET กลุ่มเป้าหมายลูกค้าของเรา

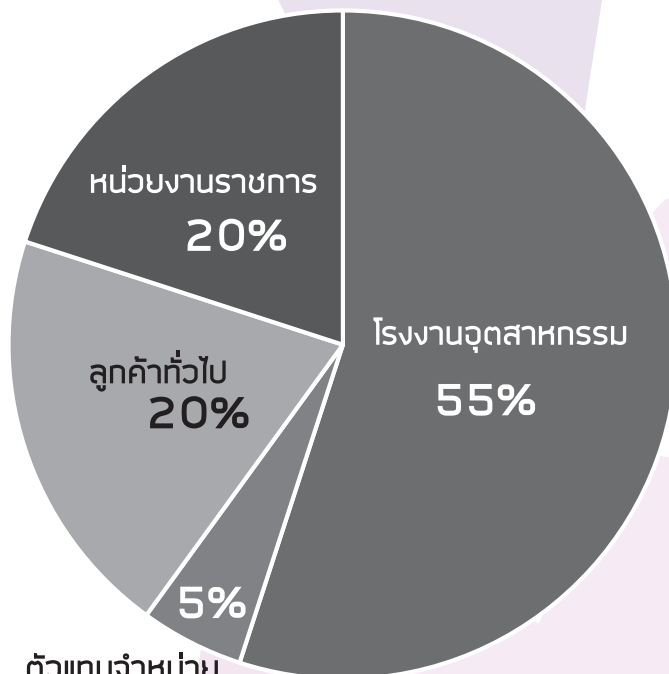

ตัวแทนจำหน่าย



เรายังเป็นศูนย์บริการทางด้านงานซ่อมและอัปเกรด
เครื่องมือวัด ทั้งในห้างแล็บ โรงพยาบาล
มหาวิทยาลัย และโรงงานอุตสาหกรรมต่างๆ
โดยช่างผู้เชี่ยวชาญ ยาวนานมากกว่า 10 ปี

WWW.ITOKIN2000.COM



CONTENTS

PAGE

| | |
|---|--------------|
| SMALL TOOLS เครื่องมือวัดขนาดเล็ก | 4-9 |
| Granite Surface Plate โต๊ะระดับ โต๊ะแกรนิต | 9-10 |
| Magnifying Lamp โคมไฟแว่นขยาย | 11-12 |
| กล้องตรวจสอบชิ้นงาน MICROSCOPE, BORE SCOPE, PROFILE PROJECTOR, VIDEO MEASURING MACHINE, COORDINATE MEASURING MACHINE | 13-19 |
| เครื่องเกี่ยวกับสี COATING, Cross Cut, Colorimeter, Spectrophotometer | 20-24 |
| Melt Flow Tester เครื่องทดสอบการหลอมไหล | 25 |
| Automatic Keyboard เครื่องทดสอบแรงกดคีย์บอร์ด | |
| Digital Wire Torsion Tester เครื่องทดสอบการบิดตัวโลหะ | |
| Roundness Cylindricity เครื่องทดสอบความกลม | 26 |
| Vibration Meter เครื่องทดสอบการสั่นสะเทือน | 27 |
| Compact Vibration เครื่องสร้างการสั่นสะเทือน | 28 |
| Glossmeter เครื่องทดสอบความเงา | 29 |
| Surface Roughness Meter เครื่องทดสอบความเรียบผิว | 30-31 |
| เครื่องวัดความหนาโลหะ Thickness Meter, Ultrasonic Test block | 34-35 |
| เครื่องทดสอบแรงบิดผาขวด Torque Tester, TORQUE TESTER | |
| Belt Tension เครื่องทดสอบแรงตึงสายพาน | |
| เครื่องวัดความแข็ง Durometer, Fruit Penetrometer, Webster / Barcol Impressor, Portable Hardness, Brinell, Rockwell Hardness Tester, Universal Hardness Tester & Reference Blocks | 37-43 |
| เครื่องวัดแรงดึงแรงกด Digital Force Gauge, Universal Testing Machine | 44-48 |
| Densimeter เครื่องทดสอบความหนาแน่นของวัตถุ | 49 |
| Gas Detector เครื่องวัดแก๊สรั่ว, Sound Level Meter เครื่องวัดเสียง, Eddy Current เครื่องวัดค่าการเหนี่ยวนำไฟฟ้า, Handheld เครื่องวัดฝุ่น, Lux Meter เครื่องวัดแสงสว่าง | 50 |
| เครื่องตัด เครื่องขัด เครื่องหล่อชิ้นงานละเอียด Ultrasonic Cutter, Specimen Cutting Machine, Grinding Polishing, Metallographic Specimen Mounting Press | 51-56 |
| Impact Testing Machine เครื่องทดสอบแรงกระแทก | 57-59 |
| Balance Scales เครื่องชั่งละเอียด | 60-63 |
| Milling Machine, Sawing Machine, Riveting Machine | 64-68 |
| Press Machine | 69-78 |
| Hand Pallet รถเข็น | 79-80 |
| รอกชนิดต่างๆ Electric Chain Hoist, Wire Rope Pulling Hoist, Double Lever Block Hoist, Chain Trolley, Chain Block Hoist, Oil Tank Chain Hoist, Motorcycle Lifting Table | 81-82 |
| Automotive Tools & Work Storage Set เครื่องมือในตู้รวม | 83 |
| Spil fyter แผ่นกั้น, ดูดซับน้ำมัน ผลิตภัณฑ์จากสหรัฐอเมริกา | 84 |
| Air Compressors เครื่องปั๊มลม, เครื่องอัดอากาศ | 85-87 |
| Generator เครื่องกำเนิดไฟฟ้า, เครื่องปั่นไฟ | 88-104 |
| CNC Router, Plasma, Fiber Laser เครื่องแกะสลักไม้ กัดลายไม้ ฉลุไม้ ป้ายโฆษณา, เครื่องตัด CNC | 105-106 |

SMALL TOOLS

เครื่องมือวัดขนาดเล็ก

Vernier Calipers Stainless Steel

| Model | Range(mm/in) | Reading(mm) | Accuracy (mm) | Price |
|----------|--------------|-------------|---------------|---------|
| ITO12-01 | 0-150/6 | 0.05 | 0.05 | 1,500.- |
| ITO12-03 | 0-200/8 | 0.05 | 0.05 | 1,800.- |
| ITO12-05 | 0-300/12 | 0.05 | 0.08 | 2,200.- |

Vernier Calipers

| Model | Range(mm/in) | Reading(mm) | Accuracy (mm) | Price |
|-----------|--------------|-------------|---------------|---------|
| ITO12-07 | 0-500/20 | 0.05 | 0.08 mm | 3,900.- |
| ITO12-07B | 0-600/24 | 0.05 | 0.10 mm | 4,900.- |
| ITO12-08 | 0-1000/40 | 0.05 | 0.10 mm | 9,900.- |



vernier Calipers

| Model | Range (mm/in) | Reading(mm/in) | Price |
|-----------|---------------|----------------|----------|
| ITO10-01 | 0-150/6 | 0.05/1/128 | 650.- |
| ITO10-02 | 0-150/6 | 0.02/1/1000 | 650.- |
| ITO10-03 | 0-200/8 | 0.05/1/128 | 850.- |
| ITO10-04 | 0-200/8 | 0.02/1/1000 | 850.- |
| ITO10-05 | 0-300/12 | 0.05/1/128 | 1,250.- |
| ITO10-06 | 0-300/12 | 0.02/1/1000 | 1,250.- |
| ITO10-07 | 0-500/20 | 0.05/1/128 | 2,200.- |
| ITO10-07B | 0-600/24 | 0.05/1/128 | 3,500.- |
| ITO10-08 | 0-1000/40 | 0.05/1/128 | 6,500.- |
| ITO10-09 | 0-1500/60 | 0.05/1/128 | 16,500.- |
| ITO10-10 | 0-2000/80 | 0.05/1/128 | 26,500.- |
| ITO10-11 | 0-3000/120 | 0.05/1/128 | 49,000.- |



ITO10-01,02



ITO10-4-03,04,05,06



ITO10-4-07,07B,08,09,10,11



ITO30-01,02,03



ITO30-04

Digital Calipers

| Model | Range (mm/in) | Reading(mm/in) | Price |
|----------|---------------|----------------|---------|
| ITO30-01 | 0-150/0-6 | 0.01/0.001 | 1,800.- |
| ITO30-02 | 0-200/0-8 | 0.01/0.001 | 2,200.- |
| ITO30-03 | 0-300/0-12 | 0.01/0.001 | 3,200.- |
| ITO30-04 | 0-600/0-24 | 0.01/0.001 | 6,500.- |

Metric Feeler Gauge



| Model | Range (mm) | Size (mm) | Quantity Pcs. | Price |
|-----------|------------|---|---------------|---------|
| ITO215-01 | 0.02-1.00 | 0.02 ,0.03 ,0.04 , 0.05 ,0.06 ,0.07 , 0.08 ,0.09 ,0.10 ,0.15 ,0.20 , 0.25 , 0.30 ,0.40 ,0.50 , 0.75 ,1.00 | 17 | 1,750.- |

Outside Micrometer Sets



| Model | Range (mm) | Reading (mm) | Accuracy (mm) | Price |
|------------|------------|--------------|---------------|----------|
| ITO52-01 | 0-100 | 0.01 | 0.005 | 4,900.- |
| ITO52-02 | 100-200 | 0.01 | 0.007 | 6,900.- |
| ITO52-02-1 | 150-300 | 0.01 | 0.009 | 7,900.- |
| ITO520-03 | 200-300 | 0.01 | 0.009 | 8,900.- |
| ITO52-04 | 300-400 | 0.01 | 0.011 | 12,000.- |

Pitch Gauge \varnothing 10 \varnothing 15 \varnothing 20 \varnothing 25 \varnothing 30 \varnothing 35 \varnothing 40 \varnothing 45 \varnothing 50



| Model | Range (mm) | Reading (mm) | Size (mm) | Quantity Pcs. | Price |
|-----------|------------|--------------|--|---------------|---------|
| ITO217-01 | 0.25-6.0 | Metric 60° | 0.25, 0.3, 0.35, 0.4, 0.45, 0.5, 0.6, 0.7, 0.75, 0.8, 0.9, 1, 1.25, 1.5, 1.75, 2, 2.5, 3, 3.5, 4, 4.5, 5, 5.5, 6 | 24 | 1,250.- |

Radius Gauge

ใช้วัดเส้นตรงกับมุมโค้งต่าง ๆ



| Model | Range (mm) | Size (mm) | Concave Pcs. | Convex Pcs. | Price |
|-----------|-------------|---|--------------|-------------|---------|
| ITO216-01 | 1-7 mm | 1, 1.25, 1.5, 1.75, 2, 2.25, 2.5, 2.75, 3, 3.5, 4, 4.5, 5, 5.5, 6, 6.5, 7 | 17 | 17 | 1,250.- |
| ITO216-02 | 7.5 - 15 mm | 7.5, 8, 8.5, 9, 9.5, 10, 10.5, 11, 11.5, 12, 12.5, 13, 13.5, 14, 14.5, 15 | 16 | 16 | 1,250.- |
| ITO216-03 | 15.5-25 mm | 15.5, 16, 16.5, 17, 17.5, 18, 18.5, 19, 19.5, 20, 21, 22, 23, 24, 25 | 15 | 15 | 1,250.- |

Outside Micrometer (Ratchet friction thimble, Chrome-plated frame)



| Model | Range (mm) | Reading (mm) | Accuracy Pcs. | Price |
|----------|------------|--------------|---------------|---------|
| ITO51-01 | 0-25 | 0.01 | 0.004 | 1,200.- |
| ITO51-02 | 25-50 | 0.01 | 0.004 | 1,650.- |
| ITO51-03 | 50-75 | 0.01 | 0.005 | 1,790.- |
| ITO51-04 | 75-100 | 0.01 | 0.005 | 1,950.- |

SMALL TOOLS

เครื่องมือวัดขนาดเล็ก

Digital Outside Micrometer



| Model | Range (mm) | Reading (mm) | Accuracy | Price |
|----------|------------|--------------|----------|---------|
| ITO69-01 | 0-25 | 0.001 | 0.004 | 3,500.- |
| ITO69-02 | 25-50 | 0.001 | 0.004 | 3,900.- |
| ITO69-03 | 50-75 | 0.001 | 0.005 | 4,500.- |
| ITO69-04 | 75-100 | 0.001 | 0.005 | 4,900.- |



| Model | Price |
|----------|-------|
| ITO75-01 | 900.- |



| Model | Size (mm) | Price |
|------------|-----------|----------|
| ITO125C-01 | 40x90 mm | 6,500.- |
| ITO125C-02 | 63x90 mm | 8,900.- |
| ITO125C-03 | 100x90 mm | 16,000.- |

Deep Throat Micrometer



Digital Inside Micrometer

| Model | Range (mm) | Reading (mm) | Accuracy (mm) | Price |
|----------|------------|--------------|---------------|---------|
| ITO82-01 | 5-30 mm | 0.01 | 0.005 | 6,500.- |
| ITO82-02 | 25-50 mm | 0.01 | 0.006 | 6,900.- |

| Model | Range (mm) | Reading (mm) | Accuracy (mm) | Throat Depth | Price |
|----------|------------|--------------|---------------|--------------|---------|
| ITO74-01 | 0-25 mm | 0.01 | 0.003 | 100 | 3,900.- |
| ITO74-02 | 0-25 mm | 0.01 | 0.004 | 150 | 4,500.- |
| ITO74-03 | 0-25 mm | 0.01 | 0.005 | 300 | 4,900.- |

Inside Micrometer



| Model | Range (mm) | Reading (mm) | Accuracy (mm) | Price |
|----------|------------|--------------|---------------|---------|
| ITO80-01 | 5-30 mm | 0.01 | 0.005 | 2,500.- |
| ITO80-02 | 25-50 mm | 0.01 | 0.006 | 2,600.- |
| ITO80-03 | 50-75 mm | 0.01 | 0.007 | 2,800.- |
| ITO80-40 | 75-100 mm | 0.01 | 0.008 | 3,000.- |

DIAL HEIGHT GAUGE



| Vernier Height Gauge With Magnifier | | | | |
|-------------------------------------|------------|--------------|---------------|---------|
| Model | Range (mm) | Reading (mm) | Accuracy (mm) | Price |
| ITO100-01 | 0-300/12 | 0.02/0.001 | 0.03 | 4,500.- |
| ITO100-02 | 0-500/20 | 0.02/0.001 | 0.05 | 5,900.- |
| ITO100-03 | 0-600/12 | 0.02/0.001 | 0.05 | 6,900.- |
| Dial Height Gauge (Double Column) | | | | |
| ITO110-01 | 0-300 | 0.01 | 0.04 | 5,900.- |
| ITO110-02 | 0-600 | 0.01 | 0.05 | 9,900.- |

DIGITAL HEIGHT GAUGE

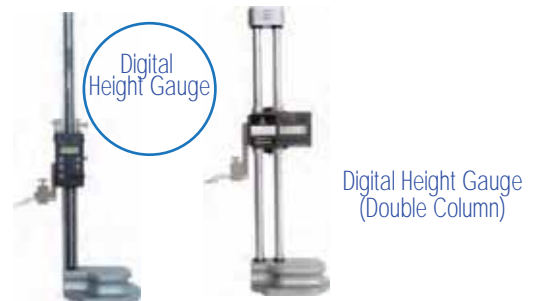

| Digital Height Gauge | | | | |
|--------------------------------------|------------|--------------|---------------|----------|
| Model | Range (mm) | Reading (mm) | Accuracy (mm) | Price |
| ITO120-01 | 0-300 /12 | 0.01 | 0.04 | 5,900.- |
| ITO120-02 | 0-600/24 | 0.01 | 0.05 | 8,900.- |
| Digital Height Gauge (Double Column) | | | | |
| ITO122-01 | 0-300/12 | 0.01 | 0.04 | 9,500.- |
| ITO122-02 | 0-600/24 | 0.01 | 0.05 | 15,500.- |

MEASURING STAND (GRADE 0)

STAND-D



STAND-E



| MEASURING STAND GRADE 0 SERIES D | | |
|----------------------------------|------------|---------|
| Model | Size (mm) | Price |
| ITO125D-01 | 150x100x40 | 4,500.- |
| ITO125D-02 | 200x150x50 | 5,000.- |
| ITO125D-03 | 300x200x50 | 5,500.- |
| MEASURING STAND GRADE 0 SERIES E | | |
| ITO125E-01 | 150x100x40 | 5,000.- |
| ITO125E-02 | 200x150x50 | 5,500.- |
| ITO125E-03 | 300x200x50 | 6,000.- |

SMALL TOOLS

เครื่องมือวัดขนาดเล็ก

Dial Indicator



| Modal | Range (mm) | Reading (mm) | Price |
|-----------|------------|--------------|---------|
| ITO170-01 | 0-10 mm | 0.01 | 1,200.- |
| ITO170-02 | 0-25 mm | 0.01 | 1,900.- |
| ITO170-03 | 0-1 mm | 0.001 | 2,500.- |

Dial Indicator (Shock Proof, High Precision, 6 Jeweled)



| Modal | Range (mm) | Reading (mm) | Price |
|-----------|------------|--------------|---------|
| ITO172-01 | 0-10 mm | 0.01 | 1,650.- |

Level Test Indicator

| Modal | Range (mm) | Reading (mm) | Price |
|-----------|------------|--------------|---------|
| ITO180-01 | 0-0.8 mm | 0.01 | 1,900.- |
| ITO180-02 | 0-0.2 mm | 0.002 | 2,900.- |



Digital Indicator



| Modal | Range (mm) | Reading (mm) | Price |
|-----------|------------|--------------|---------|
| ITO175-01 | 0-10 mm | 0.02 | 3,500.- |

inside Dial Caliper Gauge



| Modal | Range (mm) | Reading (mm) | Accuracy (mm) | Price |
|-----------|------------|--------------|---------------|---------|
| ITO200-01 | 10-30 mm | 0.01 | 0.03 | 8,500.- |
| ITO200-02 | 20-40 mm | 0.01 | 0.03 | 8,500.- |
| ITO200-03 | 30-40 mm | 0.01 | 0.03 | 8,500.- |
| ITO200-40 | 40-60 mm | 0.01 | 0.03 | 8,500.- |

Dial Thickness Gauge

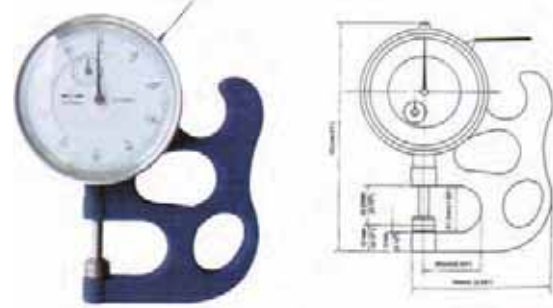

| Modal | Range (mm) | Reading (mm) | Price |
|-----------|------------|--------------|---------|
| ITO210-01 | 0-10 mm | 0.01 | 2,500.- |

Bore Gauge



| Modal | Range (mm) | Reading (mm) | Depth (mm) | Price |
|-----------|------------|--------------|------------|---------|
| ITO190-01 | 6-10 mm | 0.01 | 40 | 3,900.- |
| ITO190-02 | 10-18 mm | 0.01 | 100 | 3,900.- |
| ITO190-03 | 18-35 mm | 0.01 | 125 | 4,900.- |
| ITO190-04 | 35-50 mm | 0.01 | 150 | 4,900.- |
| ITO190-05 | 50-160 mm | 0.01 | 150 | 5,900.- |
| ITO190-06 | 160-250 mm | 0.01 | 400 | 6,900.- |
| ITO190-07 | 250-450 mm | 0.01 | 400 | 7,900.- |

Inside Digital Calliper Gauge



| Modal | Range (mm) | Reading (mm) | Accuracy (mm) | Price |
|-----------|------------|--------------|---------------|---------|
| ITO205-01 | 10-30 mm | 0.01 | 0.03 | 9,500.- |
| ITO205-02 | 20-40 mm | 0.01 | 0.03 | 9,500.- |
| ITO205-03 | 30-40 mm | 0.01 | 0.03 | 9,500.- |
| ITO205-40 | 40-60 mm | 0.01 | 0.03 | 9,500.- |

SMALL TOOLS

เครื่องมือวัดขนาดเล็ก

Three-Point Internal Micrometers Set



| Model | Range (mm) | Reading (mm) | Accuracy (mm) | Setting Rings (mm) | Extension (mm) | Price |
|----------|------------|--------------|---------------|--------------------|----------------|----------|
| ITO90-01 | 6-8 mm | 0.001 | 0.004 | 8 mm | 100 mm | 19,000.- |
| | 8-10 mm | 0.001 | 0.004 | 8 mm | | |
| | 10-12 mm | 0.001 | 0.004 | 10 mm | | |
| ITO90-02 | 12-16 mm | 0.005 | 0.004 | 16 mm | 150 mm | 12,900.- |
| | 16-20 mm | 0.005 | 0.004 | 16 mm | | |
| | 20-25 mm | 0.005 | 0.004 | 25 mm | | |
| ITO90-03 | 25-30 mm | 0.005 | 0.004 | 25 mm | 150 mm | 29,000.- |
| | 30-40 mm | 0.005 | 0.004 | 40 mm | | |
| | 40-50 mm | 0.005 | 0.005 | 40 mm | | |
| | 50-63 mm | 0.005 | 0.005 | 62 mm | | |
| ITO90-04 | 62-75 mm | 0.005 | 0.005 | 62 mm | 150 mm | 35,000.- |
| | 75-88 mm | 0.005 | 0.005 | 87 mm | | |
| | 87-100 mm | 0.005 | 0.005 | 87 mm | | |

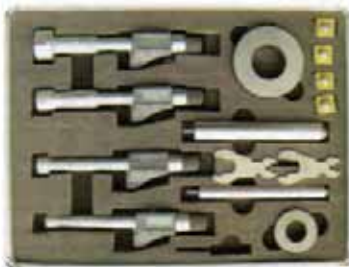

Digital-Three Point Internal Micrometers Set

| Model | Range (mm) | Reading (mm) | Accuracy (mm) | Setting Rings (mm) | Extension (mm) | Price |
|----------|------------|--------------|---------------|--------------------|----------------|----------|
| ITO92-01 | 12-16 mm | 0.001 | 0.004 | 16 mm | 150 mm | 25,000.- |
| | 16-20 mm | 0.001 | 0.004 | 16 mm | | |
| | 20-25 mm | 0.001 | 0.004 | 25 mm | | |
| ITO92-03 | 25-30 mm | 0.001 | 0.004 | 25 mm | 150 mm | 45,900.- |
| | 30-40 mm | 0.001 | 0.004 | 40 mm | | |
| | 40-50 mm | 0.001 | 0.005 | 40 mm | | |

Ring Gauge



| Model | Range (mm) | Reading (mm) | Price |
|----------|---------------|--------------|---------|
| ITO98-01 | 10, 20, 30 mm | 0.001 | 2,200.- |
| ITO98-02 | 40, 50 mm | 0.001 | 2,900.- |
| ITO98-03 | 75 mm | 0.001 | 3,900.- |
| ITO98-04 | 100 mm | 0.001 | 4,900.- |

GAUGE BLOCK



| Gauge Block | | | ราคาจำหน่ายแบบแยกชิ้น |
|-------------|-------|-----------|-----------------------|
| Model | Grade | Size (mm) | Price |
| ITO96-01 | 1 | 1 mm | 1,500.- |
| ITO96-02 | 1 | 5 mm | 1,500.- |
| ITO96-03 | 1 | 10 mm | 1,600.- |
| ITO96-04 | 1 | 20 mm | 1,600.- |
| ITO96-05 | 1 | 50 mm | 1,800.- |
| ITO96-06 | 1 | 100 mm | 1,900.- |
| ITO96-07 | 1 | 200 mm | 4,500.- |
| ITO96-08 | 1 | 300 mm | 5,500.- |
| ITO96-09 | 1 | 400 mm | 6,500.- |

| Gauge Block Set | | | | | ราคาจำหน่ายแบบยกเซต | |
|-----------------|-------|-------------|-----------|------------|---------------------|----------|
| Model | Grade | Size (mm) | Step (mm) | Block (mm) | Weight (kg) | Price |
| ITO94-01 | 1 | 1.001-1.009 | 0.001 | 9 | 2.9 | 15,000.- |
| | | 1.01-1.49 | 0.01 | 49 | | |
| ITO94-02 | 0 | 0.5-9.5 | 0.5 | 19 | | 25,000.- |
| | | 10-100 | 10 | 10 | | |

SMALL TOOLS

เครื่องมือวัดขนาดเล็ก

Magnetic Base



ITO160-01 ITO160-02 ITO160-03

| Model | Type | Magnetic Power (kgf) | Price |
|-----------|------------|----------------------|---------|
| ITO160-01 | Standard | 80 | 1,400.- |
| ITO160-02 | Mechanical | 80 | 1,800.- |
| ITO160-03 | Hydraulic | 80 | 2,500.- |

Knife Edged Square 90°



| Model | Size (mm) | Grade (mm) | Price |
|-----------|------------|------------|---------|
| ITO130-01 | 75x50 mm | 0 | 900.- |
| ITO130-02 | 100x70 mm | 0 | 1,300.- |
| ITO130-03 | 150x100 mm | 0 | 1,800.- |
| ITO130-04 | 200x130 mm | 0 | 2,200.- |
| ITO130-05 | 300x200 mm | 0 | 2,900.- |



Flat Edged wide base Square 90°

| Model | Size (mm) | Grade (mm) | Price |
|-----------|------------|------------|---------|
| ITO135-02 | 100x70 mm | 1 | 1,400.- |
| ITO135-03 | 150x100 mm | 1 | 1,900.- |
| ITO135-04 | 200x130 mm | 1 | 2,300.- |
| ITO135-05 | 300x200 mm | 1 | 3,300.- |

Less Parallax Universal Bevel Protractor



| Model | Range | Reading | Accuracy | Price |
|-----------|--------|---------|----------|---------|
| ITO140-01 | 0-360° | 5' | 5' | 2,900.- |

Granite Inspection Plate

**ราคานี้รวมแท่นวาง



| Model | Size (mm) | Accuracy (mm) | Price |
|--------------|---------------|---------------|-----------|
| ITO-SL125-01 | 600x450x100 | 0.004 mm | 13,500.- |
| ITO-SL125-02 | 750x500x130 | 0.005 mm | 22,000.- |
| ITO-SL125-03 | 1000x750x150 | 0.007 mm | 35,000.- |
| ITO-SL125-04 | 1500x1000x200 | 0.009 mm | 95,000.- |
| ITO-SL125-05 | 2000x1000x200 | 0.013 mm | 145,000.- |

GRANITE SURFACE PLATE

(Grade 0)



หากท่านต้องการไซส์อื่นๆ กรุณาติดต่อ สายด่วน 082-1288881, 081-7731860 หรือ OFFICE 02-9744354-6

CAST IRON SURFACE PLATE

โต๊ะระดับ,โต๊ะแกรนิต

Inspection Plate

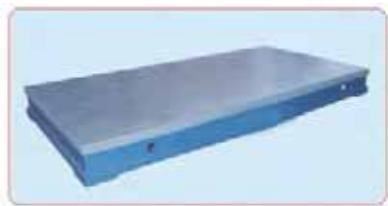

Floor Type Borer Bench

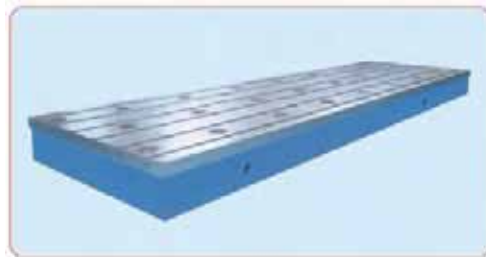

Standad Size

| Model | Size (mm) | Precision Grade (μm) | | | | Price |
|----------|-----------|----------------------|---------|---------|---------|----------|
| | | Grade 0 | Grade 1 | Grade 2 | Grade 3 | |
| ITO-CI01 | 600 x 400 | 20 | | | | 14,500.- |
| ITO-CI01 | 900 x 600 | 30 | | | | 24,000.- |
| ITO-CI01 | 1000x750 | | 18 | | | - |
| ITO-CI01 | 1000x1000 | | 20 | | | - |
| ITO-CI01 | 1200x1000 | | 20 | | | - |
| ITO-CI01 | 1500x1000 | | 24 | | | - |
| ITO-CI01 | 2000x1000 | | 26 | 52 | | - |
| ITO-CI01 | 2000x1500 | | | 56 | | - |
| ITO-CI01 | 2000x2000 | | | 60 | | - |
| ITO-CI01 | 3000x1000 | | | | 168 | - |
| ITO-CI01 | 3000x1500 | | | | 174 | - |
| ITO-CI01 | 3000x2000 | | | | 184 | - |
| ITO-CI01 | 4000x2000 | | | | 219 | - |
| ITO-CI01 | 4000x3000 | | | | 240 | - |
| ITO-CI01 | 6000x3000 | | | | 308 | - |

| Model | Size (mm) | Precision Grade (μm) |
|----------|---------------|----------------------|
| | | Grade 1 |
| ITO-CI01 | 1120x3800x350 | 18 |
| ITO-CI01 | 1885x4000x400 | 20 |
| ITO-CI01 | 1885x5600x400 | 20 |
| ITO-CI01 | 1885x6400x400 | 24 |
| ITO-CI01 | 1885x8000x400 | 26 |

| Model | Size (mm) | Precision Grade (μm) | | |
|----------|-----------|----------------------|---------|---------|
| | | Grade 1 | Grade 2 | Grade 3 |
| ITO-CI01 | 1200x1000 | 20 | | |
| ITO-CI01 | 1500x1000 | 24 | | |
| ITO-CI01 | 1500x1500 | 25 | | |
| ITO-CI01 | 2000x1000 | 26 | | |
| ITO-CI01 | 2000x1500 | | 56 | |
| ITO-CI01 | 2000x2000 | | 60 | |
| ITO-CI01 | 2500x1500 | | 64 | |
| ITO-CI01 | 2500x2000 | | 68 | |
| ITO-CI01 | 2500x2500 | | 72 | |
| ITO-CI01 | 3000x1000 | | | 168 |
| ITO-CI01 | 3000x1500 | | | 174 |
| ITO-CI01 | 3000x2000 | | | 184 |
| ITO-CI01 | 3000x2500 | | | 186 |
| ITO-CI01 | 3000x3000 | | | 210 |
| ITO-CI01 | 4000x1000 | | | 210 |
| ITO-CI01 | 4000x1500 | | | 210 |
| ITO-CI01 | 4000x2000 | | | 219 |
| ITO-CI01 | 4000x2500 | | | 228 |
| ITO-CI01 | 4000x3000 | | | 240 |
| ITO-CI01 | 5000x1500 | | | 249 |
| ITO-CI01 | 5000x2000 | | | 255 |
| ITO-CI01 | 5000x2500 | | | 264 |
| ITO-CI01 | 5000x3000 | | | 287 |
| ITO-CI01 | 6000x1500 | | | 287 |
| ITO-CI01 | 6000x2000 | | | 293 |
| ITO-CI01 | 6000x2500 | | | 300 |
| ITO-CI01 | 6000x3000 | | | 308 |
| ITO-CI01 | 8000x1500 | | | 366 |
| ITO-CI01 | 8000x2000 | | | 370 |
| ITO-CI01 | 8000x2500 | | | 375 |
| ITO-CI01 | 8000x3000 | | | 382 |

Cast Iron Surface Plate Series

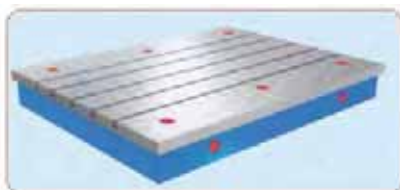

Single-Face Normal Plate

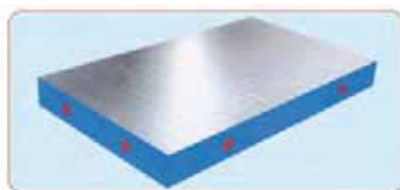

Coordinate Lineating Plate

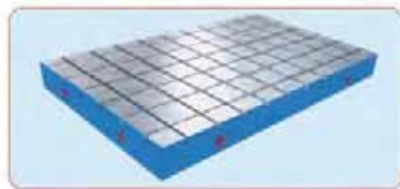

Mounting Plate

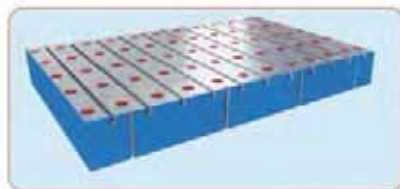

Riveting and Welding Plate

*****หากท่านต้องการไซต้อื่นๆกรุณาติดต่อได้ที่
สายด่วน 082-1288881, 081-7731860
หรือ OFFICE 02-9744354-6**

MAGNIFYING LAMP

โคมไฟแว่นขยาย

MAGNIFYING LAMP (CLAMP)

โคมไฟแบบหนีบโต๊ะ

| Model ITO-CMLSV | Fluorescent | LED |
|-----------------|--------------------|---------|
| Type | Clamp | |
| Magnification | 3X, 5X, 8X, 10X | |
| Diameter | φ 127 mm / 05 inch | |
| Power | 220V/110V AC | |
| Price | 3,950.- | 4,200.- |



MAGNIFYING LAMP (FLOOR)

โคมไฟแว่นขยายแบบตั้งพื้น

| Model ITO-FLOOR | Fluorescent | LED |
|-----------------|--------------------|---------|
| Type | Floor | |
| Magnification | 3X, 5X, 8X, 10X | |
| Diameter | φ 127 mm / 05 inch | |
| Power | 220V/ 110V AC | |
| Price | 5,900.- | 6,500.- |



MAGNIFYING LAMP (X-Y Type)

โคมไฟแว่นขยายชนิด X-Y

| Model ITO-DMLXY | Fluorescent | LED |
|-----------------|-----------------|---------|
| Type | X-Y Type | |
| Magnification | 3X, 5X, 8X, 10X | |
| Diameter | φ 127 mm | |
| Power | 220V/110V AC | |
| Price | 3,950.- | 4,200.- |



MAGNIFYING LAMP (SWING TYPE)

โคมไฟแว่นขยายชนิด สวิง

| Model ITO-DMLSV | Fluorescent | LED |
|-----------------|-----------------|---------|
| Type | Swing Type | |
| Magnification | 3X, 5X, 8X, 10X | |
| Diameter | φ 127 mm | |
| Power | 220V/110V AC | |
| Price | 3,950.- | 4,200.- |

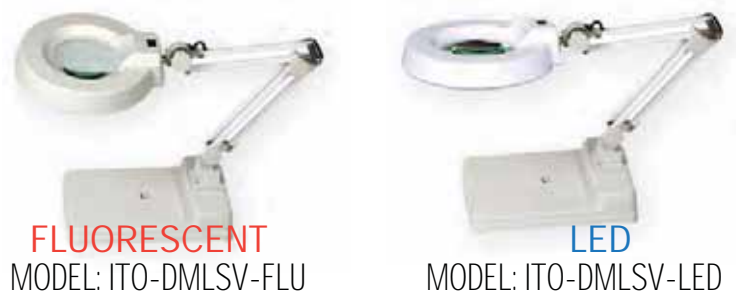

| Magnifying Lamp | Model : ITO-MA-106 |
|--------------------------------------|--|
| Type | Headband |
| Magnification | 1.8X, 2.6X, 5.8X |
| Lens material | Acrylic (Processed by crack-proof rigid coating) |
| Lens size | 2,3 89 x 29 mm ; 1 Single -Lens diameter: 28 mm |
| Use two AAA batteries (not included) | |
| Price | 1,800.- |

Magnifying Lamp Headband

โคมไฟแว่นขยายแบบคาดหัว

MODEL: ITO-MA-106



MAGNIFYING LAMP

โคมไฟแว่นขยาย

MODEL: ITO8069D-2BHC 



 MODEL: ITO8069BEC

| Model | ITO8069D-2BHC | ITO8069BEC |
|----------------|----------------------------|----------------|
| Len Material | Glass | |
| Lens size | 7.5" x 6.2" (190 x 155 mm) | |
| Diopter | 5 diopter | |
| Voltage | 110V - 120V / 220V - 240V | |
| Light Source | 2 x PL 9W Fluorescent Lamp | |
| Standard Mount | Table Clamp | |
| Arm Swing | Length 24" | |
| Gross Weight | 16Kgs | 20Kgs |
| Net Weight | 14Kgs | 18Kgs |
| Optional Mount | Table Clamp, Floorstand | |
| Price | 5,900.- | 5,900.- |

| Model | ITO-8069 |
|--------------|--|
| Len Material | crystal clear glass lens |
| Lens size | 7.5" x 6.2" (190 x 155 mm) |
| Diopter | 3 - 5 diopter magnifying strength (2.25X) |
| Voltage | AC 220V - 230V |
| Light Source | T5 2x9W energy saving compact fluorescent bulb |
| Price | 5,900.- |



 MODEL: ITO8069

MAGNIFYING LAMP ACCESSORIES



Clamp
Price: 550.-



| Lens Magnifying Lamp | ITO-L3X | ITO-L5X | ITO-L10X |
|----------------------|----------------|----------------|----------------|
| Size | 3X | 5X | 10X |
| Diameter | 127 mm | | |
| Price | 1,500.- | 1,500.- | 1,500.- |



ITO-MS-1 SWING



ITO-MS-2 SWING

MAGNIFYING SCOPE

| Model | ITO-MS-1 SWING | ITO-MS2 FLOOR |
|--|-------------------------------|-----------------|
| Magnification | 2X, 4X, 8X, 10X (4Lens) | |
| Type | Swing | Floor |
| Super -Large field of viewing and depth of field | | |
| Illumination | AC220V | |
| Output | 12V 20W Halogen Lamp With cup | |
| Price | 49,000.- | 59,000.- |

MICROSCOPE

Stero Zoom, Trinocular Stereo Zoom, FIX Stereo กล้องจุลทรรศน์

Stereo Zoom Microscope



| | |
|----------------------|-----------------|
| Model | SMZ-745 |
| Specification | |
| Eyepiece | 10x |
| Objective Zoom range | 7-45 x |
| Ring Lamp | 8w |
| Price | 19,000.- |

Trinocular Stereo Zoom Microscope



| | |
|----------------------|-----------------|
| Model | T-SMZ-745 |
| Specification | |
| Eyepiece | 10x |
| Objective Zoom range | 7-45 x |
| Ring Lamp | 8w |
| Price | 24,000.- |

FIX Stereo Zoom Microscope



| | |
|---------------------|-----------------|
| Model | F-SMZ-745 |
| Specification | |
| Eyepiece | 10x |
| Objective Fix range | 10x / 30x |
| Ring Lamp | 8w |
| Price | 15,000.- |

RING LAMP

FLUORESCENT RING LAMP



With Cover

| | |
|-----------|----------------|
| Model | FLU-01 |
| Ring Lamp | 8w |
| Price | 2,800.- |



With Only

| | |
|-----------|--------------|
| Model | FLU-02 |
| Ring Lamp | 8w |
| Price | 500.- |

LED Adjustable Ring Lamp



| | |
|----------------|----------------|
| Model | 56-LED |
| LED | 56 PCS |
| Adjustable | Brightness |
| Long lift time | |
| Price | 3,800.- |

MICROSCOPE

กล้องจุลทรรศน์

Binocular Biological, Inverted Metallurgic, Upright Metallurgical, Upright Metallurgical, Metallurgical, CCD Camera

Binocular Biological Microscope



| Model | XSZ-152B |
|----------------|------------------------|
| Specification | |
| Eyepiece | WF 10x |
| Objective Lens | 4x, 10x, 40x, 100x oil |
| Stage Size | 125x130 mm |
| Moving range | 75 x 50 mm |
| Halogen Bulb | 6V/20W/220V |
| Price | 23,500.- |

INVERTED METALLURGIC Microscope



| Model | IMM-70 (Bright-Field) |
|----------------------|---------------------------------|
| Specification | |
| Eyepiece | 10x/20 mm |
| Plan Objective | PL10x, PL20x, PL50x, PL100x Dry |
| Double layer Stage | Moving range 30x30 mm |
| Light System Halogen | 12v/20w |
| Power Supply | AC90-240v |
| Price | 125,000.- |

Upright Metallurgical Microscope



| Model | UMM-16B |
|-------------------|---|
| Specification | |
| Eyepiece | WF 10x |
| Plan achromatic | PL5x, PL10, PL20x, PL50x, PL100x Dry |
| Eyepiece Tube | Trinocular |
| Illumination Unit | 6v 20w, Halogen Lamp, adjustable brightness |
| Halogen Bulb | 6V/20W/220V |
| Price | 115,000.- |

Upright Metallurgical Microscope



| Model | UMM-100 |
|--------------------|---------------------------|
| Specification | |
| Objective Lens | PL5x, PL10x, PL20x, PL40x |
| Wide Field | WF10x /18 |
| Double Layer Stage | 230x230 mm |
| Moving Range | 150x150 mm |
| Illumination | AC220v /50Hz |
| Price | 145,000.- |

Metallurgical Microscope



| Model | SMZ-745 |
|----------------|--|
| Specification | |
| Eyepiece | WF 10x/ 22 mm |
| Plan Objective | PL5x, PL10x, PL20x, PL50x |
| Illumination | 12v 30w Halogen and Brightness Control |
| Working Stage | 185x140 mm |
| Moving Range | 35x30 mm |
| Price | 135,000.- |

CCD Camera For Microscope



| Model | DCM-500 |
|--------------|-----------------|
| Resolution | 5 M Pixel |
| Price | 25,000.- |

- Measuring and Recording software include
- Free! Training and Installation

BORE SCOPE

กล้องตรวจสอบในท่อ, เครื่องยนต์

Display Unit Adro Vision V70 with OD50 mm Fiber Glass probe



- Out side diameter: 50mm
- 150mm focus length
- Field of view 60'
- Working length : 60-120 Meter
- 18 Strong LED light
- Length Counter
- Built-in Transmitter option
- Supports monitor 360' rotating
- Water/oil proof: 1Bar
- * 60, 80, 100, 120 Meter

ติดต่อสอบถาม สายด่วน 082-1288881, 081-7731860
หรือ OFFICE 02-9744354-6

Articulation

*สามารถสั่งขนาดและความยาวของสายได้ตามต้องการ

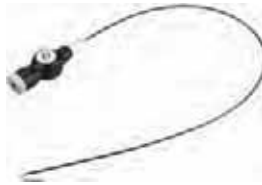

Flexible Articulation



Metal - Braided Articulation



Rigid Articulation

Diameter : 3.9mm, 4.3mm, 5.5mm, 8mm

Adro Vision V70



- 7" Digital Display
- IR Remote Control
- Support Audio & Video Recoring
- Support Snapshot
- Support 12 V. and 3.7 Power Tube

ติดต่อสอบถาม สายด่วน 082-1288881, 081-7731860
หรือ OFFICE 02-9744354-6

USB Scope

Adro USB 3512

- Window XP/ Vista / Windows 7 / Windows 8
- Support Snapshot & Video Recording 



สอบถามราคา 02-9744354-6

Adro WiFi

- Apple / Android Mobile System
- NB /PC Within WiFi Function
- Support Snapshot & Video Recording 



สอบถามราคา 02-9744354-6

Adro Vision V55



- 3.5" LCD Display
- Support Snapshot & Video Recording
- Support 3.7 V. Power Tuber

ติดต่อสอบถาม สายด่วน 082-1288881, 081-7731860
หรือ OFFICE 02-9744354-6

PROFILE PROJECTOR

เครื่องวัดขนาดชิ้นงานแบบละเอียด ชนิดแสงเงา



Model: JT12B3



สินค้า
ขายดี

Model: SP3015 B

Free Printer



สินค้า
ขายดี

Model: SP3020 B

Free Printer

| | |
|---|-----------------------|
| MODEL | JT12B3 |
| Projection Screen | Φ 250 mm |
| Lens Standad 10x / Optional 20 x 50x 100x | |
| Range of X Y Z | X 100mm Y 50mm Z 50mm |
| Resolution | 0.001 mm |
| Price: | 140,000.- |

| | |
|---|--------------------------|
| MODEL | SP3015 B |
| Projection Screen | φ300mm |
| Lens Standad 10x / Optional 20 x 50x 100x | |
| Range of X Y Z | X 150mm Y 50 mm Z 0~90mm |
| Resolution | 0.001mm |
| Price: | 180,000.- |

| | |
|---|---------------------------|
| MODEL | SP3020 B |
| Projection screen | φ300mm |
| Lens Standad 10x / Optional 20 x 50x 100x | |
| Range of X Y Z | X 200 mm Y 100 mm Z 80 mm |
| Resolution | 0.001 mm |
| Price: | 220,000.- |



Model: SP-3015



Model: SP-3025



สินค้า
ขายดี

Model: SP16-2010

| | |
|---|---------------------------|
| MODEL | SP-3015 |
| Projection screen | φ300mm |
| Lens Standad 10x / Optional 20 x 50x 100x | |
| Range of X Y Z | X 150 mm Y 100 mm Z 85 mm |
| Resolution | 0.001 mm |
| Price: | 195,000.- |

| | |
|--|----------------------|
| MODEL | SP-3025 |
| Projector screen | 360° |
| Lens Standad 10X / Optional 20X 50X 100X | |
| Range of X Y Z | X 250 Y 100 Z 100 mm |
| Resolution | 0.001 mm |
| Price: | 290,000.- |

| | |
|--------------------------------------|--------------------------|
| MODEL | SP16 |
| Screen | φ400mm |
| Lens Stanaad 10 x / Optional 20x 50x | |
| Range of X Y Z | X 200mm Y 100 mm Z 100mm |
| Resolution | 0.0005mm |
| Price: | 450,000.- |



Model: JT21



Model: SP-3020



Model: SHP-4025

| | |
|---|------------------------|
| MODEL | JT21 |
| Screen | φ350mm |
| Lens Standad 10 x / Optional 5x 20x 50x | |
| Range of X Y Z | X 200 Y 100 Z 0~100 mm |
| Resolution | 0.001mm |
| Price: | 450,000.- |

| | |
|--|---------------------------|
| MODEL | SPH-3020 |
| Projection screen | φ300mm |
| Lens Standad 10x / Optional 20x 50x 100x | |
| Range of X Y Z | X 200 mm Y 100 mm Z 85 mm |
| Resolution | 0.001 mm |
| Price : | 350,000.- |

| | |
|---|----------------------|
| MODEL | SPH-4025 |
| Projector screen | φ400 |
| Lens Standad 10x / Optional 5x 20x 50x 100x | |
| Range of X Y Z | X 250 Y 150 Z 100 mm |
| Resolution | 0.001 mm |
| Price: | 450,000.- |

VIDEO MEASURING MACHINE

เครื่องวัดขนาดชิ้นงานแบบละเอียด กล้องวัดชิ้นงาน วัดขนาดไมครอน

E-SERIES



| MODEL | E200 | E300 | E400 |
|------------------------|---------------|-------------|-------------|
| X,Y,Z travel range | 200X100X200 | 300X200X200 | 400X300X200 |
| Z move range | 200 mm | 200 mm | 200 mm |
| X,Y resolution | 0.001 mm | 0.001 mm | 0.001 mm |
| Lens magnify | 0.7~4.5X | 0.7~4.5X | 0.7~4.5X |
| Computer SET + LCD 19" | | | |
| Optional part | 0.5X, 2X Lens | | |
| Price: | 290,000.- | 350,000.- | 430,000.- |

PORTABLE 2010



| MODEL | PORTABLE2010 |
|------------------------|---------------|
| X,Y Measurement travel | 200X100X70 mm |
| Overall dimensions | 50X50X70 cm |
| Operation model | Manual |
| Resolution | 0.001 mm |
| X,Y,Z Measurement | (4+L/200) um |
| Price: | 185,000.- |

VIDEOMEASURING PROBE-SERIES

E200-PROBE



| MODEL | E200 PROBE | E300 PROBE | E400 PROBE |
|------------------------|----------------|-------------|-------------|
| X,Y,Z travel range | 200X100X200 | 300X200X200 | 400X300X200 |
| Z move range | 200 mm | 200 mm | 200 mm |
| X,Y resolution | 0.001 mm | 0.001 mm | 0.001 mm |
| Lens magnify | 0.7~4.5X | 0.7~4.5X | 0.7~4.5X |
| Computer SET + LCD 19" | | | |
| Optional part | 0.5X, 2X Lens | | |
| Price: | **สอบถามราคา** | | |

A-SERIES



สินค้า
วางตัว



| MODEL | AC300 CNC | AC400 CNC | AC500 CNC |
|----------------------------|---|-------------|-------------|
| Measuring range(mm) | 300x200x180 | 400x300x180 | 500x400x180 |
| Accuracy of X-Y axis (μm): | 3+L/200 | | |
| Accuracy of Z axis (μm): | 5+L/200 | | |
| Repeatability (mm) | 0.002 | | |
| Moving speed (mm/s): | X-Y: 0~400 Z: 0~100 | | |
| Camera type: | SBK-HC536 700 lines industrial color camera | | |
| Price: | 490,000.- | 590,000.- | 690,000.- |

INSTANT VISION MEASURING SYSTEM

NEW UPDATE

SQM-SERIES

กล้องวัดชิ้นงานละเอียด
แยกงานดีงานเสีย อัตโนมัติ



| MODEL | SQM-30 | SQM-60 | SQM-80 | SQM-160 |
|------------------------|--|--------------|---------------|---------------|
| Lens | 0.3X Double | 0.17X Double | 0.088X Double | 0.088X Double |
| | Telecentric Lens | | | |
| Working Distance | 110 mm | 110 mm | 120 mm | 160 mm |
| Wide Field | Φ 30 mm | Φ 60 mm | Φ 80 mm | Φ 120 mm |
| Measurement Accuracy | 4 um | 6 um | 8 um | 15 um |
| Repeatability Accuracy | 2 um | 4 um | 4 um | 10 um |
| Camera | 2/3" 5 million pixel B/W camera (Ethernet) | | | |
| Illumination | Digital controls, automatic memory, Telecentric Green LED Contour illumination, Ring white LED illumination | | | |
| PC System | 21" Pcsystem | | | |
| Test Time | <55 (Less than 100 tests) | | | |
| Output data | Test data, reports, determine the results (OK, NG, WAIT), etc | | | |
| Function | 2D measurements: points, lines, circles, arcs, angles, distance, oval, O-rings, Groove, rectangle, parallelism | | | |
| Auxiliary Function | Intersection, parallel, perpendicular, tangent, bisection | | | |
| Measurement Mode | Manual / Automation | | | |
| Power Supply | AC100~240V. 50~60Hz | | | |
| Price: | 890,000.- | 980,000.- | สอบถามราคา | สอบถามราคา |

COORDINATE MEASURING MACHINE

เครื่องวัดชิ้นงานแบบ 3 มิติ PORTABLE CMM / ARM CMM

100 SERIES

200 SERIES

BACES 3D SERIES

Kozaka Laboratory Ltd.

แบรนด์คุณภาพจาก ญี่ปุ่น



| MODEL | Measuring Diameter | Repeatability (mm) | Repeatability (Inch) | Volumetric Uncertainty (mm) | Volumetric Uncertainty (Inch) |
|------------------|--------------------|--------------------|----------------------|-----------------------------|-------------------------------|
| Baces3D M100 | 8.5 Feet | 0.035mm | 0.0014" | 0.060mm | 0.0024" |
| Baces3D G100 | 10.5 Feet | 0.050mm | 0.0020" | 0.090mm | 0.0035" |
| Baces3D M200-LE | 7.8 Feet | 0.07mm | 0.0028" | 0.13mm | 0.0051" |
| Baces3D M200 | 8.5 Feet | 0.060mm | 0.0024" | 0.100mm | 0.0039" |
| Baces3D G200 | 10.5 Feet | 0.080mm | 0.0031" | 0.150mm | 0.0059" |
| Baces3D XG200 | 13.7 Feet | 0.400mm | 0.0157" | 0.350mm | 0.0138" |
| Baces3D G200 AR | 10.5 Feet | 0.250mm | 0.0098" | 0.250mm | 0.0098" |
| Baces3D XG200 AR | 13.7 Feet | 0.400mm | 0.0157" | 0.400mm | 0.0157" |

สอบถามราคาสาขาคอน 082-1288881, 081-7731860
หรือ OFFICE 02-9744354-6

| MODEL | | VMC5506M | VMC5546M | VMC5566M | VMC5506L |
|----------------------|--|---------------------------|----------|----------|--------------|
| Maximum moving range | x axis | 3500mm | | | 3900mm |
| | Y axis | 3500mm | | | 3900mm |
| | Z axis | 3200mm | | | 3600mm |
| Measurement accuracy | Reproducibility | 2σ:0.04mm | | | 2σ:0.06mm |
| | Measurement accuracy | 2σ:0.06mm | | | 2σ:0.08mm |
| Measuring arm | Total length | 1750mm (including offset) | | | 1950mm |
| | Degree of freedom | Junctions: 6 | | | |
| | Mass | About 9.7kg | | | About 10.2kg |
| Price: | ติดต่อสอบถาม สาขาคอน 082-1288881, 081-7731860 หรือ OFFICE 02-9744354-6 | | | | |



| MODEL | | VMC6606M | VMC6646M | VMC6666M |
|----------------------|--|---------------------------|----------|----------|
| Maximum moving range | x axis | 3500mm | | |
| | Y axis | 3500mm | | |
| | Z axis | 3360mm | | |
| Measurement accuracy | Reproducibility | 2σ:0.03mm | | |
| | Measurement accuracy | 2σ:0.04mm | | |
| Measuring arm | Total length | 1750mm (including offset) | | |
| | Degree of freedom | Junctions: 6 | | |
| | Mass | About 9kg | | |
| Price: | สอบถามราคา สาขาคอน 082-1288881, 081-7731860 หรือ OFFICE 02-9744354-6 | | | |



แบรนด์คุณภาพจาก ญี่ปุ่น

| MODEL | | VSC 3222 |
|----------------------|----------------------|--------------|
| Maximum moving range | x axis | 3100mm |
| | Y axis | 2950mm |
| | Z axis | 3615mm |
| Measurement accuracy | Reproducibility | 2σ:0.06mm |
| | Measurement accuracy | 2σ:0.15mm |
| Measuring arm | Total length | 1550mm |
| | Degree of freedom | Junctions: 6 |
| | Mass | About 7.5kg |

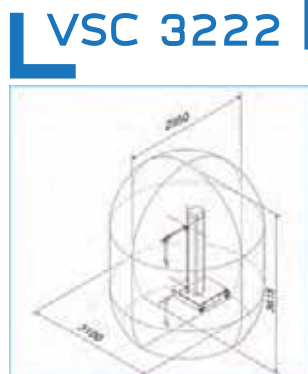

ติดต่อสอบถาม สาขาคอน 082-1288881, 081-7731860
หรือ OFFICE 02-9744354-6

COORDINATE MEASURING MACHINE

เครื่องวัดชิ้นงานแบบ 3 มิติ



METIC 565

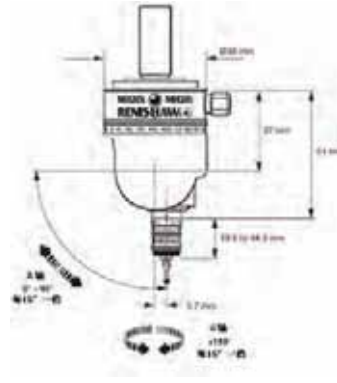

| | |
|--|---|
| MODEL | METIC 565 |
| Measuring Strokes | 500x600 x 500(mm) |
| Overall Dimension | 1248x1280 x 2500 (mm) |
| Max part weight | 900kg |
| Resolution | 0.5(μm) |
| Accuracy according GB/T16857.2-1997 equal ISO 10 360 | |
| Environment Specifications | |
| Room required specifications | Average room temperature 18 - 22°C Maximum thermal gradients 1°C /hour, 2 °C/day, 1°C /Meter, |
| Air supply system | Min. air pressure 0.5 Mpa Min. air consumption 0.1 m ³ /min |
| Electrical requirements | Voltage 220 Vac ± 10% Frequency 50 Hz Current 10 A |
| Allowed Maximum Floor Vibration | Frequency Range : 0 ~19 Hz 19~75 Hz > 75 Hz Maximum Amplitude : 0.0011 mm 0.0011~0.002 mm 0.002 mm |

สอบถามราคา สายด่วน
082-1288881, 081-7731860
หรือ OFFICE 02-9744354-6



**METI 8106
SEMI-AUTOMATIC**

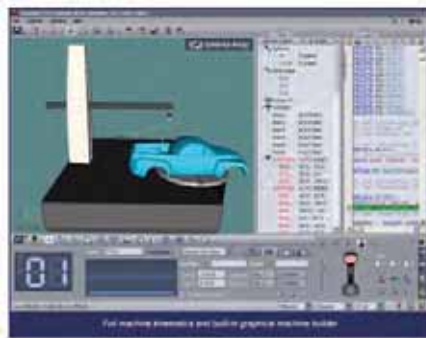

| NAME | SPECIFICATION | NO | PICTURE |
|---------------------|---------------|----|---------|
| probe(PS49R) | φ1.5x20 | 2 | |
| probe(PS27R) | φ2.5x20 | 1 | |
| probe(PS17R) | φ4.0x20 | 2 | |
| Lengthen pole(SE4) | 10mm | 1 | |
| Lengthen pole(SE5) | 20mm | 1 | |
| Lengthen pole(SE18) | 40mm | 1 | |
| Probe center(SC2) | 5-way | 1 | |
| Probe tool | | 1 | |

| | |
|------------------------|---|
| MODEL | METIC 8106 SEMI -AUTOMATIC |
| Measuring Strokes | 800x1000 x 600(mm) |
| Structure | Moving Bridge |
| Resolution | 0.5(μm) |
| Machine Bearing | 1100kg |
| Overall Gross Weight | 1200 kg |
| Operate Manner | semi automatic |
| Measuring System | UK Renishaw glass scale |
| Worktable : | High Precision Marble Flat Roof |
| Leading Track | High Precision Marble Leading Track High Precision air bearing |
| Computer Set + LED 19" | |

สอบถามราคา 082-1288881, 081-7731860
หรือ OFFICE 02-9744354-6

COATING THICKNESS GAUGE

เครื่องวัดความหนา



NEW UPDATE

ULTRASONIC THICKNESS PT-200

วัดสึบนพลาสติก, ปูน, ไม้

| PosiTechtor PT-200 | PT-200B/Std | PT-200B/Adv | PT-200C/Std | PT-200C/Adv |
|---------------------------|---|------------------|-------------------------------|------------------|
| Measure total thickness | Yes | | | |
| Measure individual layers | | Yes | | Yes |
| Graphic display | | Yes | | Yes |
| Typical applications | Polymer coatings on wood, plastic, etc, | | on concrete, fiberglass, etc. | |
| Range | 13-1000 microns 0.5-40 mils | | 50-3800 microns 2-150 mils | |
| Accuracy | ±(2 microns + 3% of reading) ±(0.1 mils + 3% of reading) | | | |
| Minimum individual | | 13 microns | | 50 microns |
| | | 0.5 mils | | 2 mils |
| Price | 95,000.- | 125,000.- | 110,000.- | 135,000.- |



MODEL: TM-550FN

| | |
|-----------------|---|
| Model | TM550FN |
| Measuring range | 0 to 1300um (0 to 51.2mils) |
| Accuracy | (3% of readingx2um) ± (3% of reading 0.078mils) |
| Resolution | 0um~ 999um (1um), 1000um~ 1300um (0.01mm); 0mils~ 39.39mils (0.01mils), 39.4mils~ 51.2mils(0.1mils) |
| Price | 13,900.- |

สามารถวัดได้ทั้งโลหะและโลหะย่น
การวัดที่ 0 - 1300 ไมครอน
บันทึกหน่วยความจำได้ 99 ค่า
สามารถดูค่า Maximum, Minimum,
Average ได้

CM-8856

เครื่องวัดความหนาโลหะ



| | |
|-------------------|-----------------|
| Model | CM-8856 |
| Range | 0 -1250 µm |
| Memory | 99 |
| Max, Min, Average | |
| Resolution | 0.1µm |
| Price | 19,500.- |

MODEL: TM-510 PLUS

| Model | TM 510 F | TM510 F&FN |
|-------------------|-----------------|-----------------|
| Range | 0-1500µm | |
| Memory | 500 | |
| Max, Min, Average | | |
| Price | 29,000.- | 34,000.- |



CM-8821 F (ชนิดวัดบนโลหะ) CM-8822 FN (ชนิดวัดบนโลหะและอลูมิเนียม)

| Model | CM-8821 F | CM-8822 FN |
|-------------|-----------------|-----------------|
| Range | 0 - 1000µm | |
| LCD Display | 4 digits | |
| Resolution | 0.1µm | |
| Price | 16,500.- | 18,000.- |



POSIPEN MAGNETIC PULL-OFF THICKNESS GAUGE

| | |
|----------|---|
| Model | PP-1 |
| Range | 5-500 µm |
| Measures | on hot surface, on small surface, in different positions |
| Price | 28,000.- |



MAGNETIC COATING PRICE: 29,000.-



MODEL
PT-G (0-200 um)
PT-F (0-2000 um)

DC 3000 FX SERIES

| Model | DCF3000 FX | DCFN 3000 FX |
|-------------|------------------------|-----------------|
| Range | 0-1500µm | |
| Memory | 10000 Readings | |
| Data Output | Infrared Irda Standard | |
| Price | 42,000.- | 55,000.- |



WET FILM COMB เครื่องวัดความหนาฟิล์มเปียก

MODEL: BGD

| Model | CM-8000 |
|-------|----------------|
| Range | 25-3000µm |
| Price | 7,500.- |

| Model BGD | | |
|-----------|----------------|----------|
| BGD531/1 | 10-100 µm | (@10 µm) |
| BGD531/2 | 20-200 µm | (@20 µm) |
| BGD531/3 | 50-750 µm | (@75 µm) |
| BGD531/4 | 250-700 µm | (@50 µm) |
| BGD531/5 | 300-2500 µm | (@50 µm) |
| Price | 6,500.- | |

